

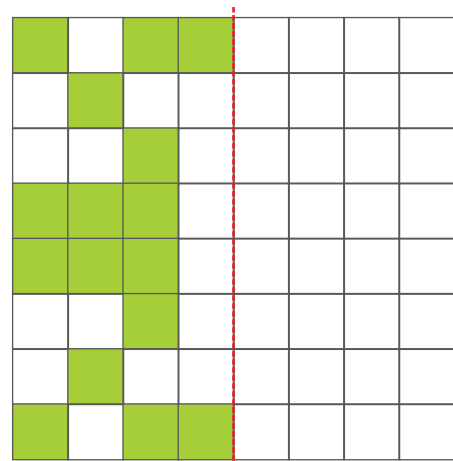

Symmetrie

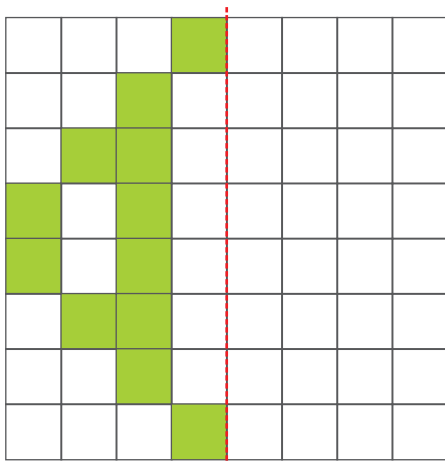

Ergänze die Figuren gespiegelt (achsensymmetrisch).

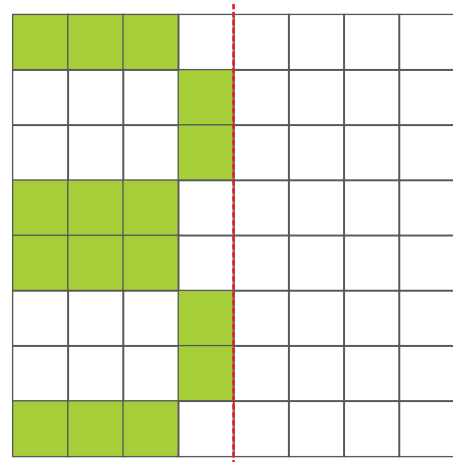
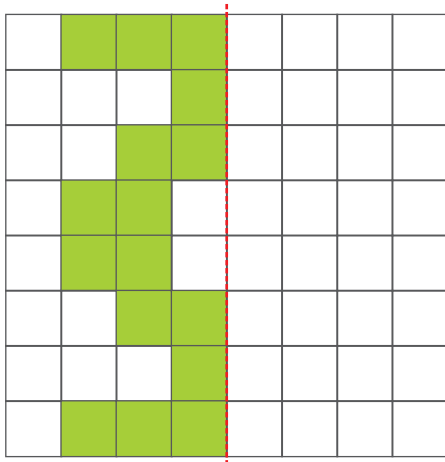
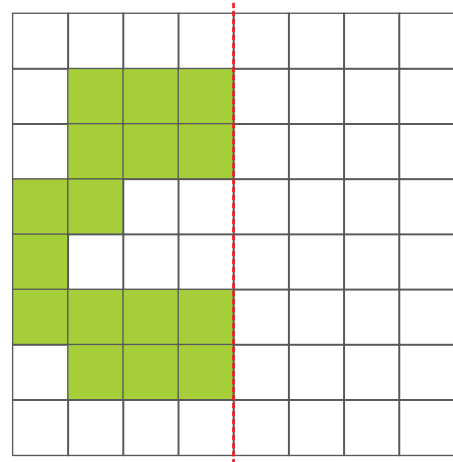
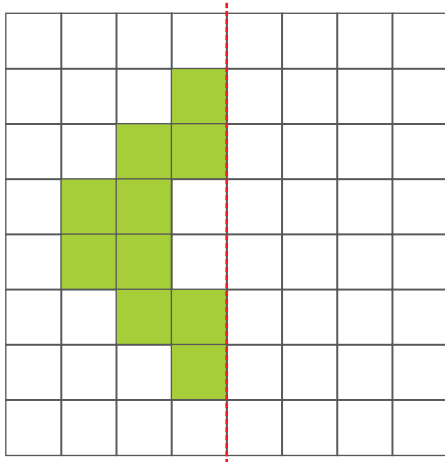



Symmetrie



Ergänze die Figuren gespiegelt (achsensymmetrisch).

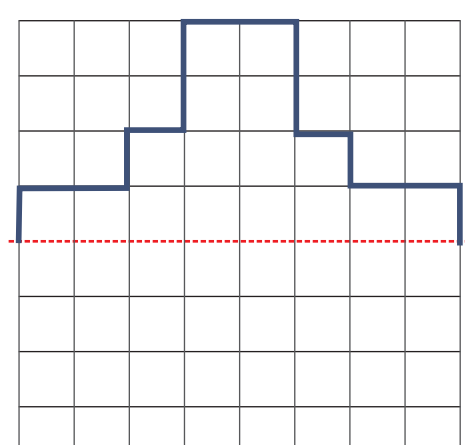
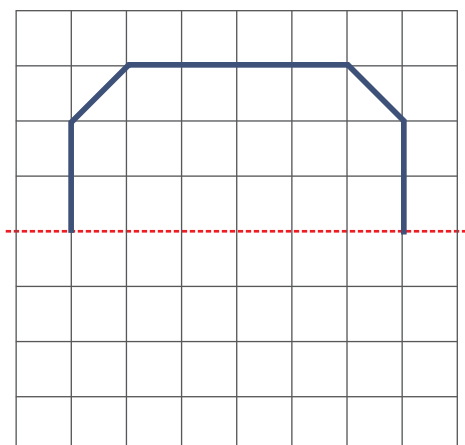
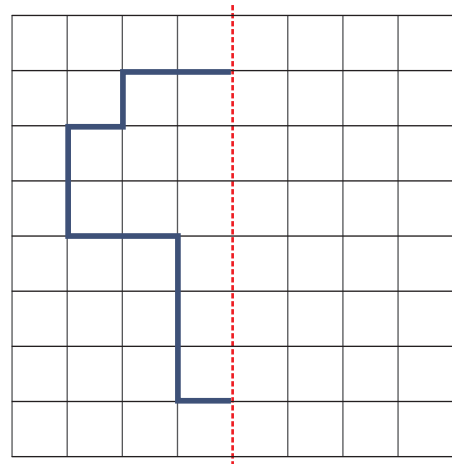
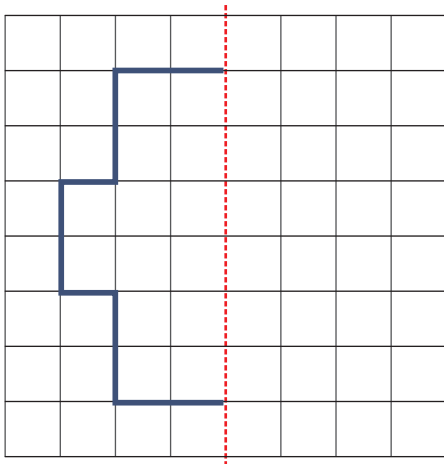
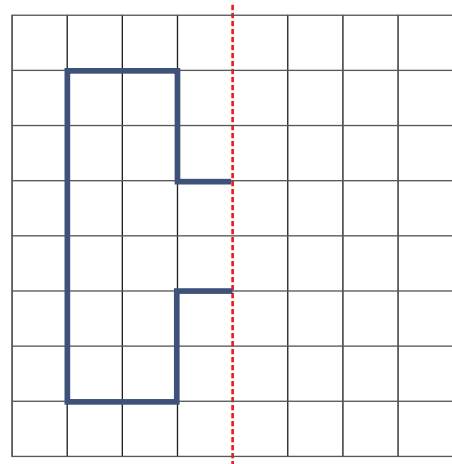
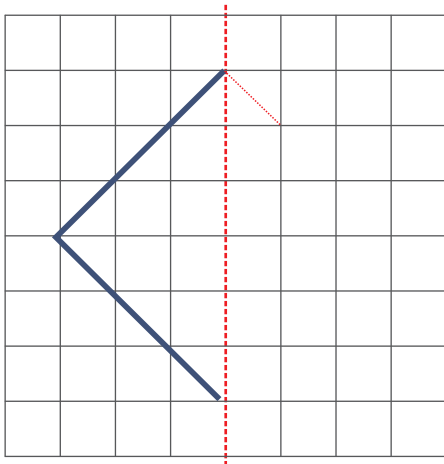



Symmetrie



Ergänze die Figuren gespiegelt (achsensymmetrisch).

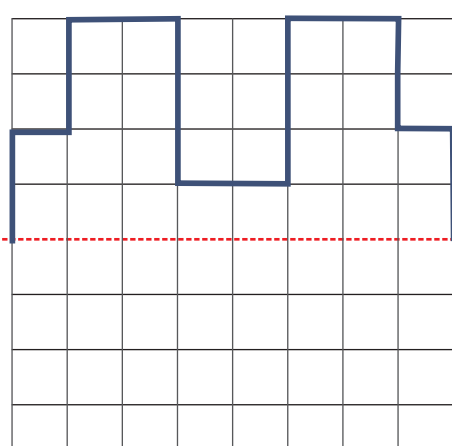
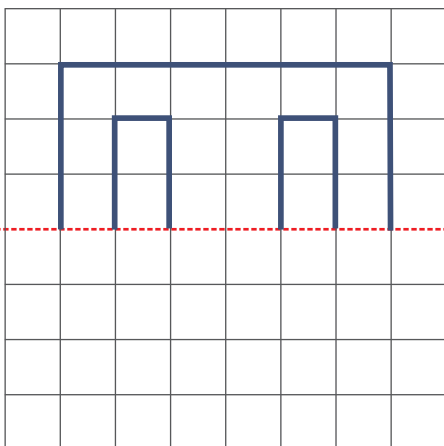
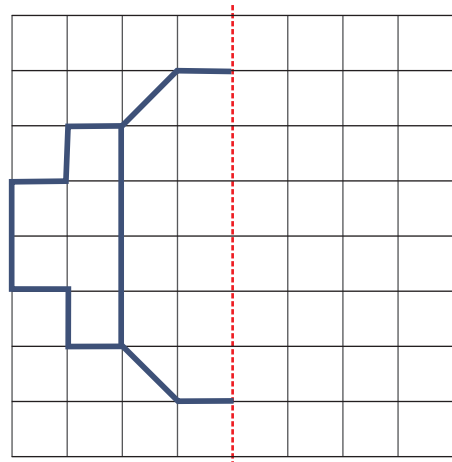
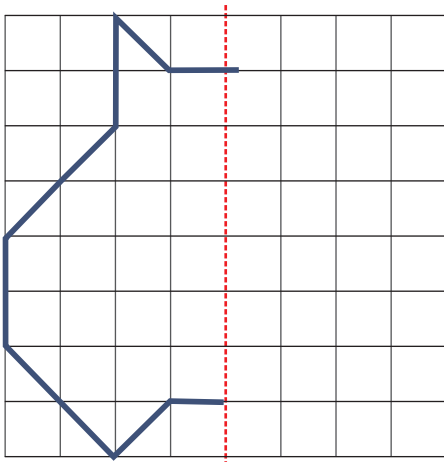
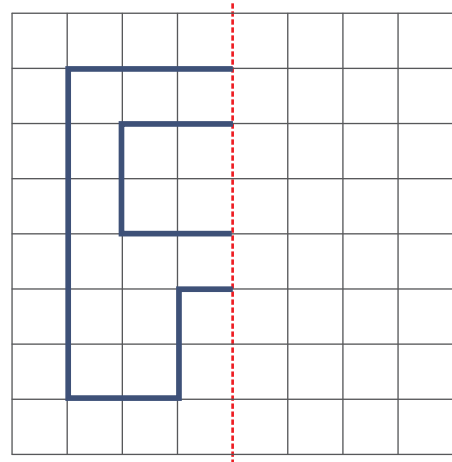
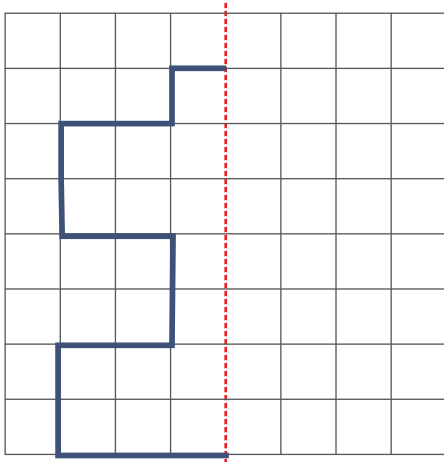



Achsensymmetrie



Trage die Spiegelachse in den Figuren ein.

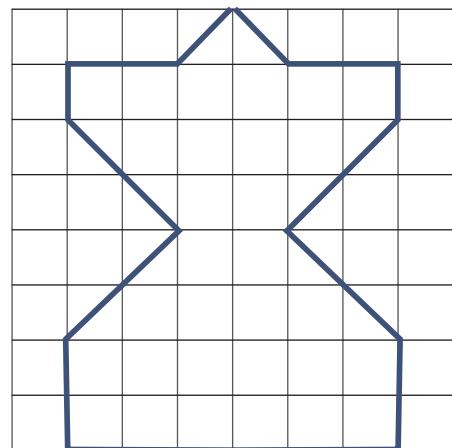
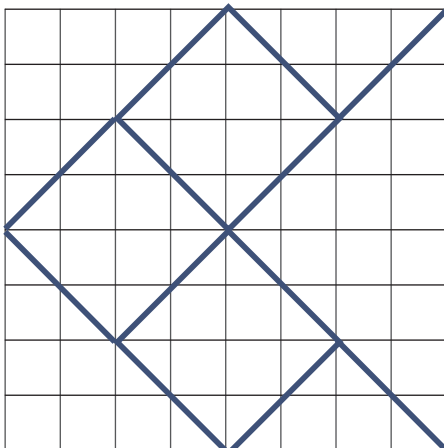
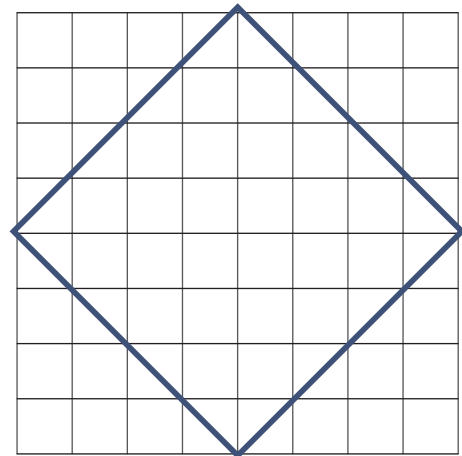
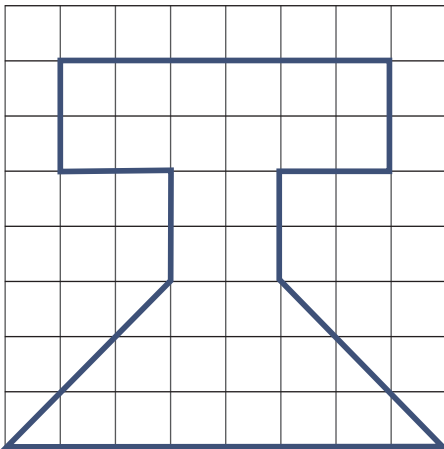
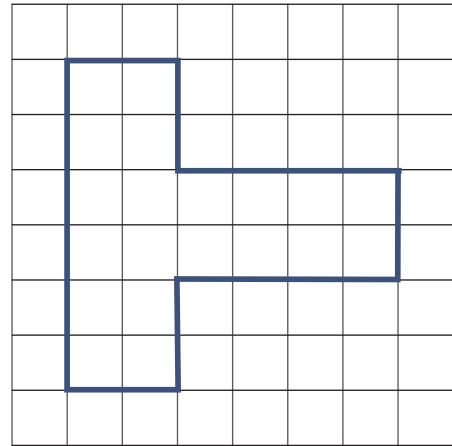
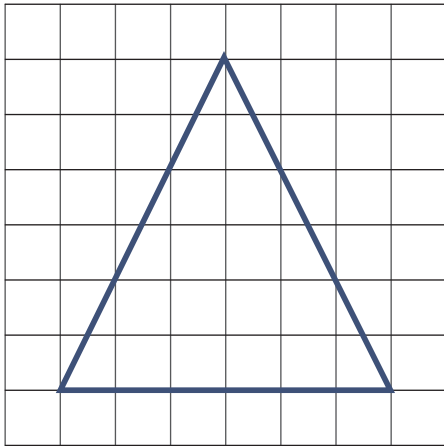



Achsensymmetrie



Spiegle die Figuren an der Spiegelachse.

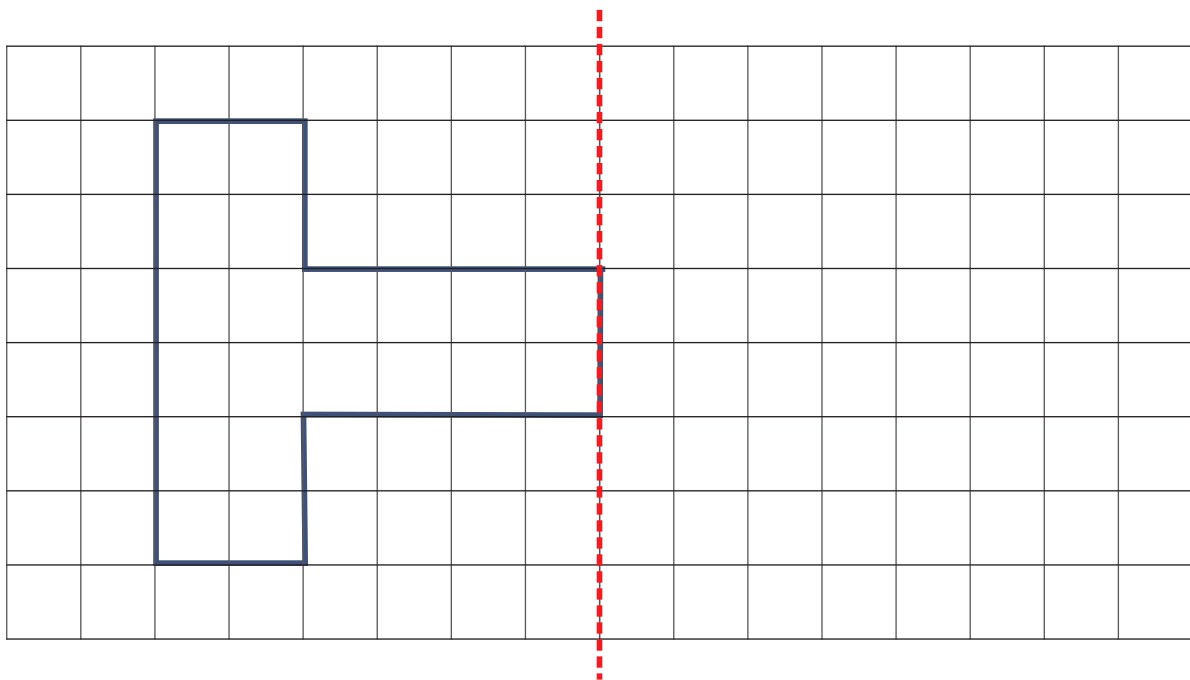
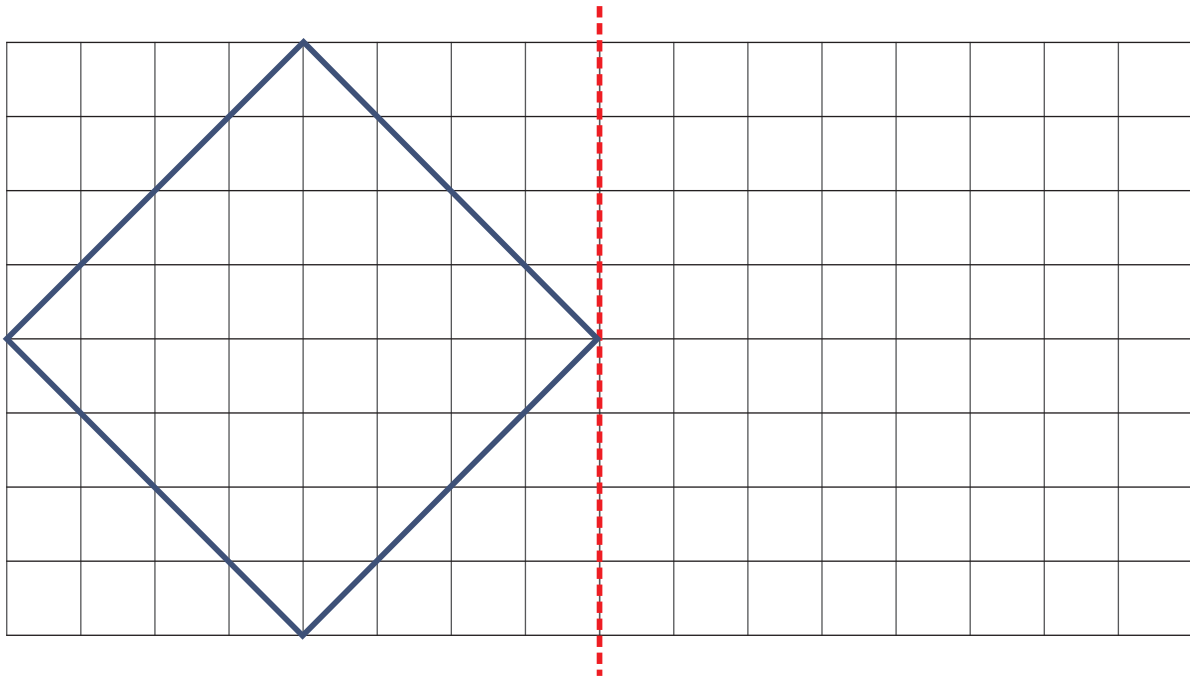



Achsensymmetrie



Spiegle die Figuren an der Spiegelachse.

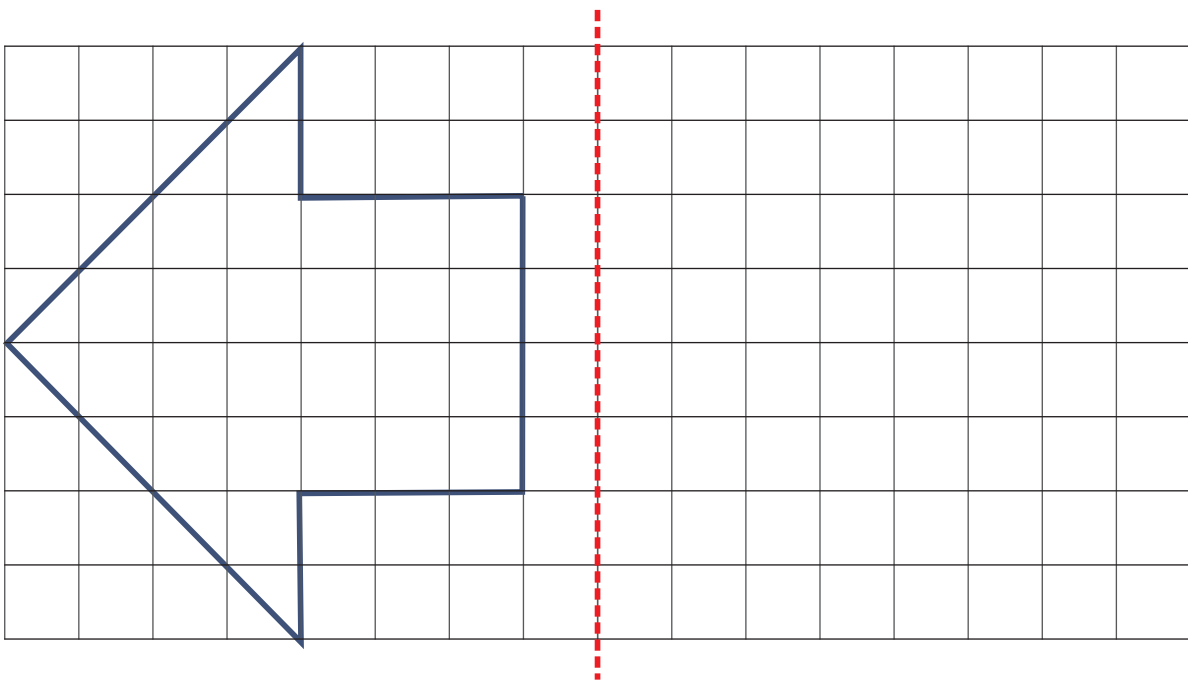
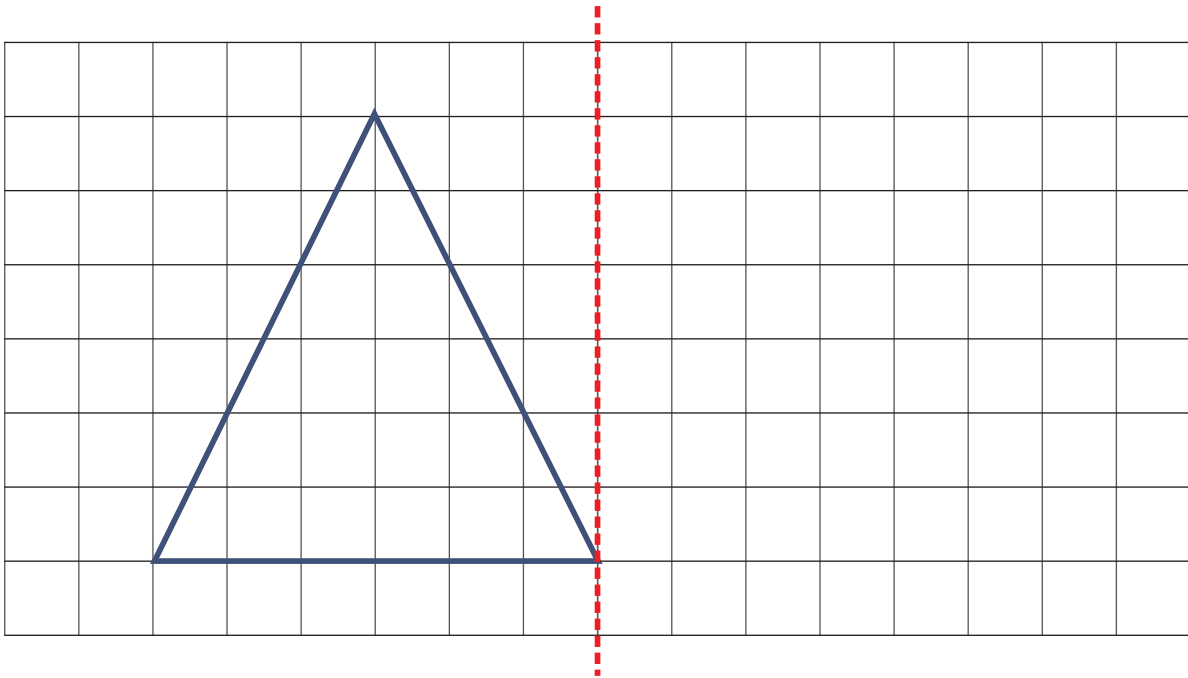



Symmetrie



Ergänze die Figuren gespiegelt (achsensymmetrisch).

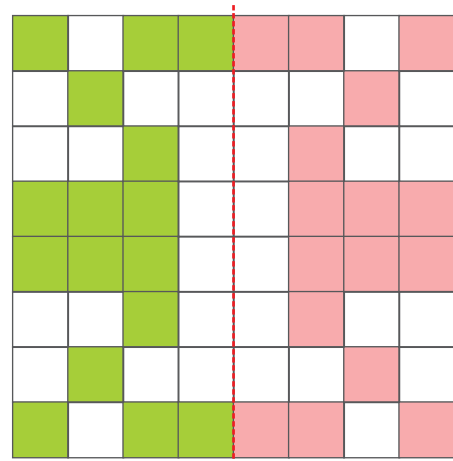
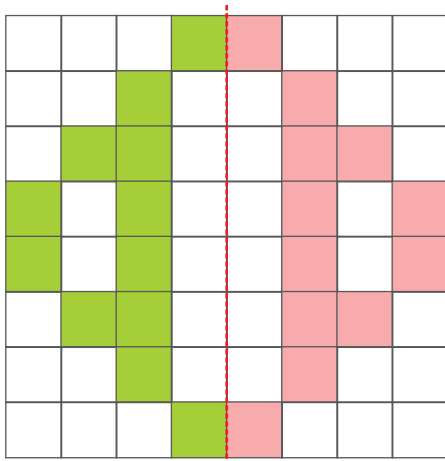
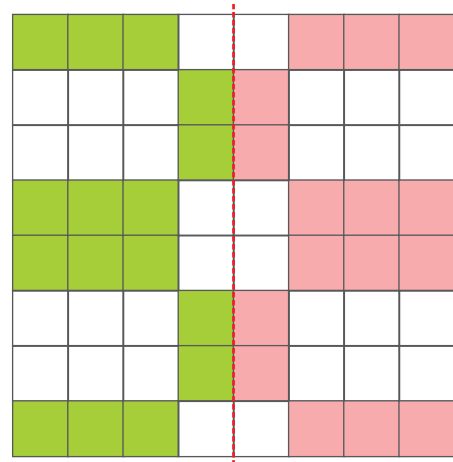
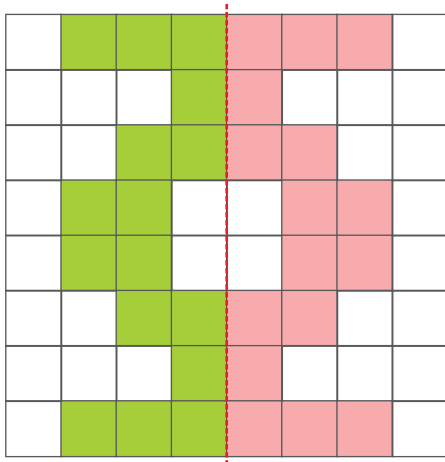
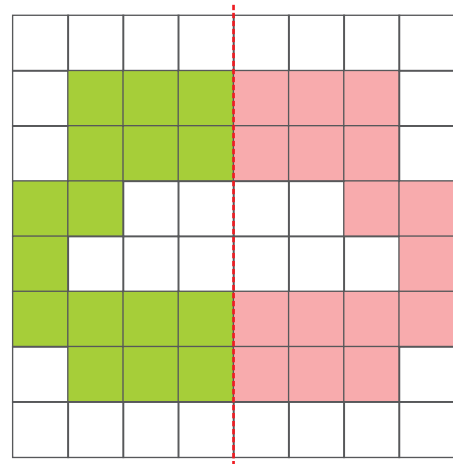
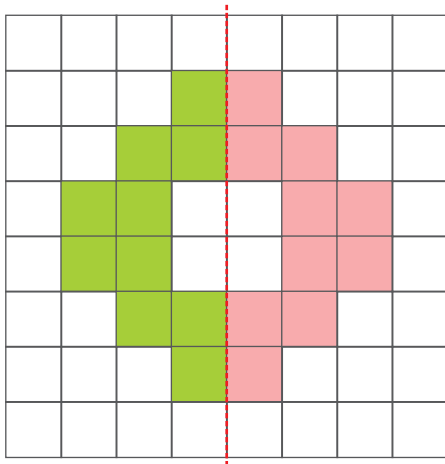

Symmetrie



Ergänze die Figuren gespiegelt (achsensymmetrisch).

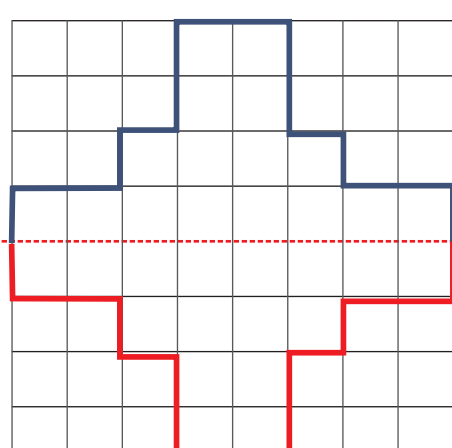
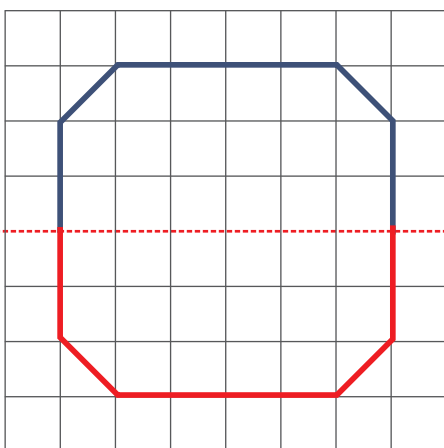
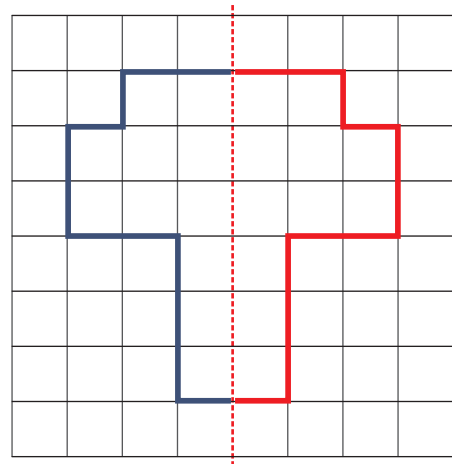
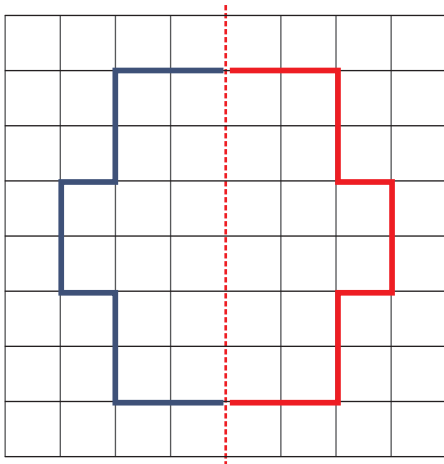
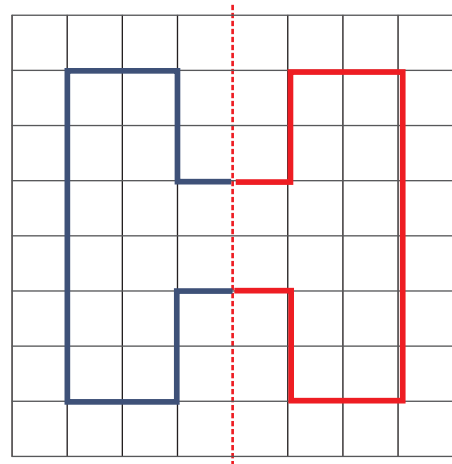
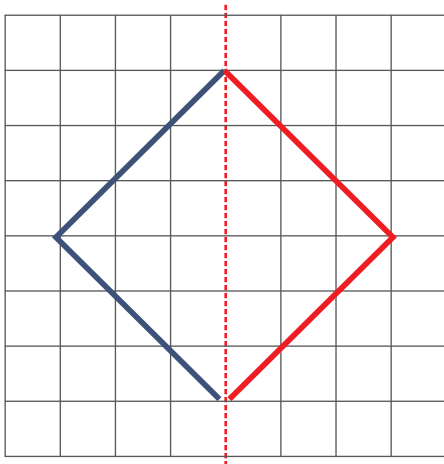



Symmetrie



Ergänze die Figuren gespiegelt (achsensymmetrisch).

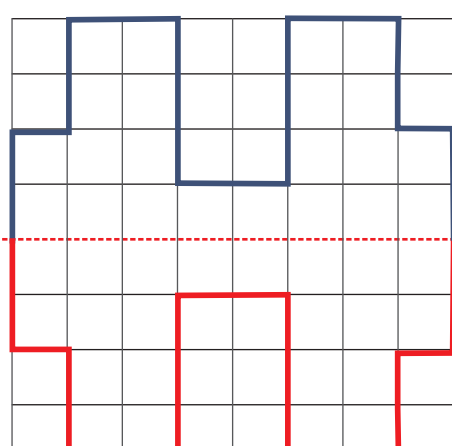
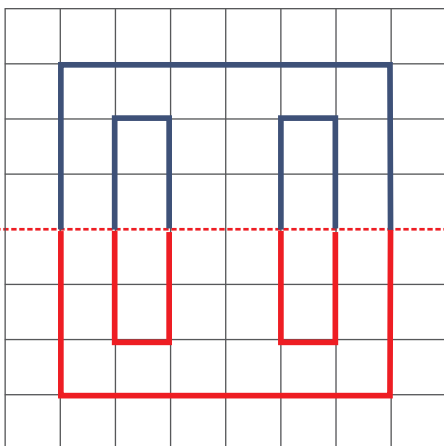
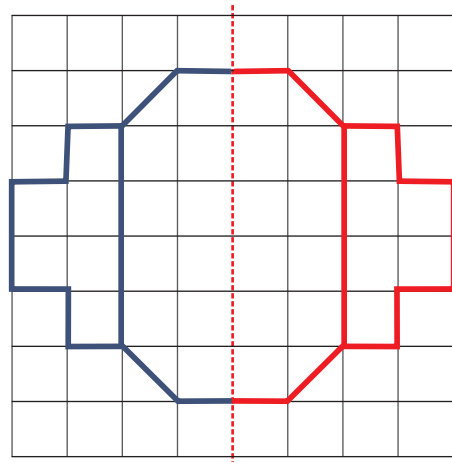
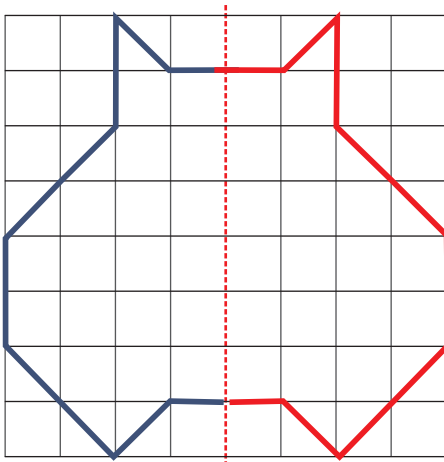
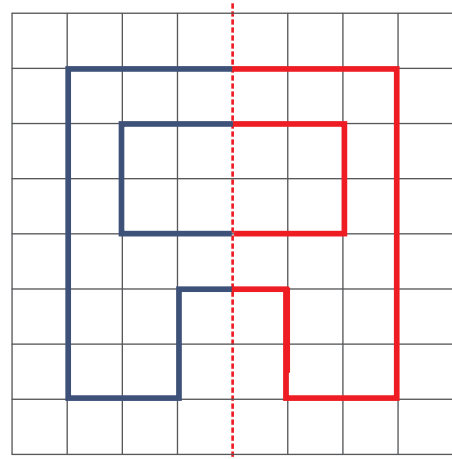
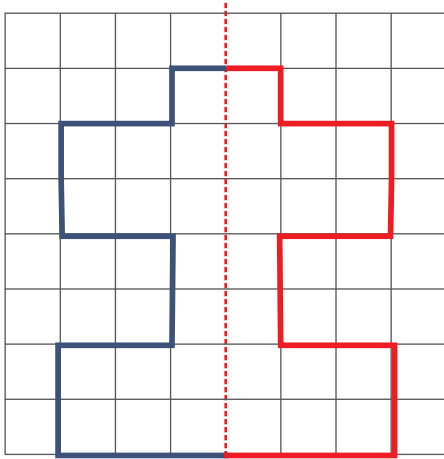

Achsensymmetrie



Trage die Spiegelachse in den Figuren ein.

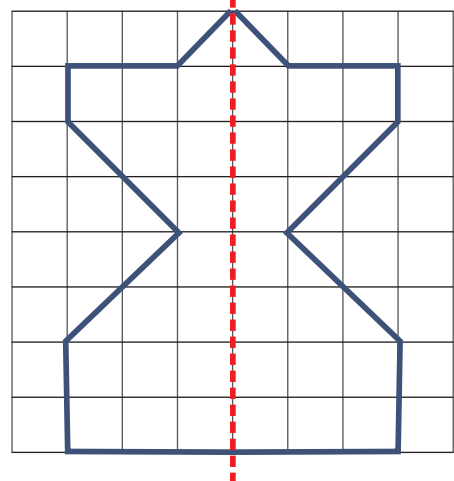
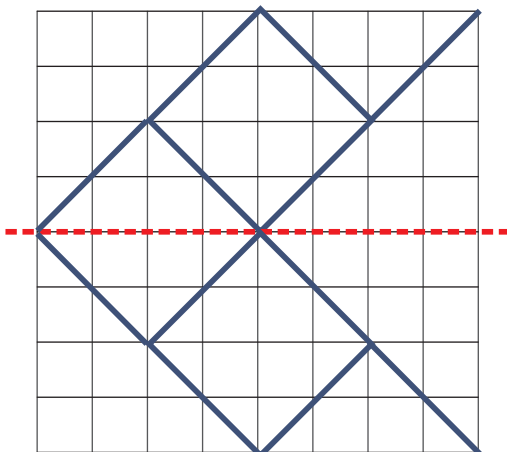
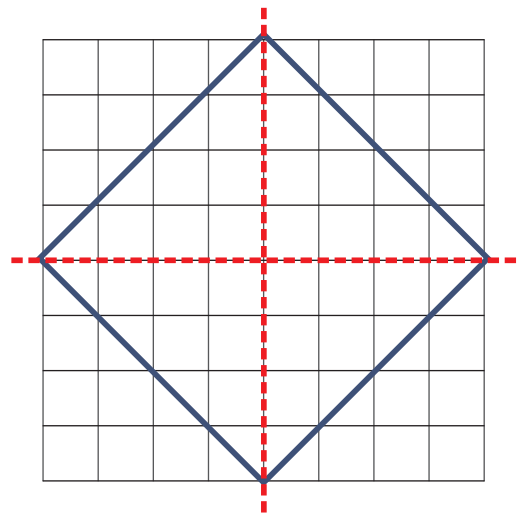
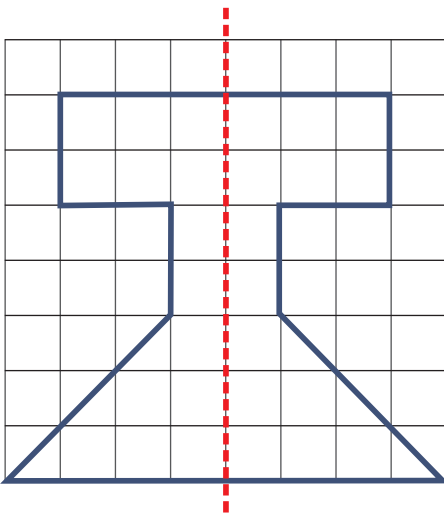
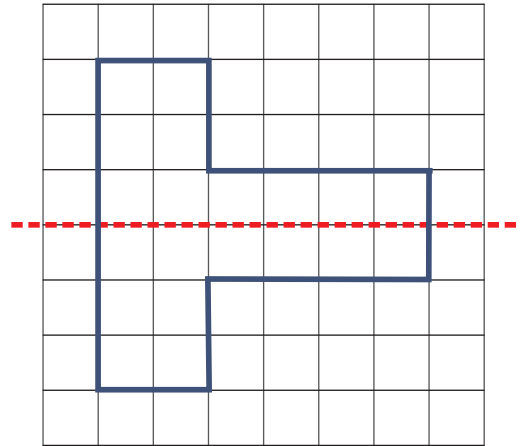
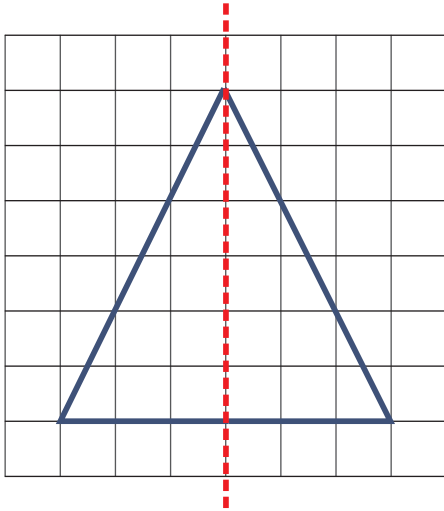



Achsensymmetrie



Spiegle die Figuren an der Spiegelachse.

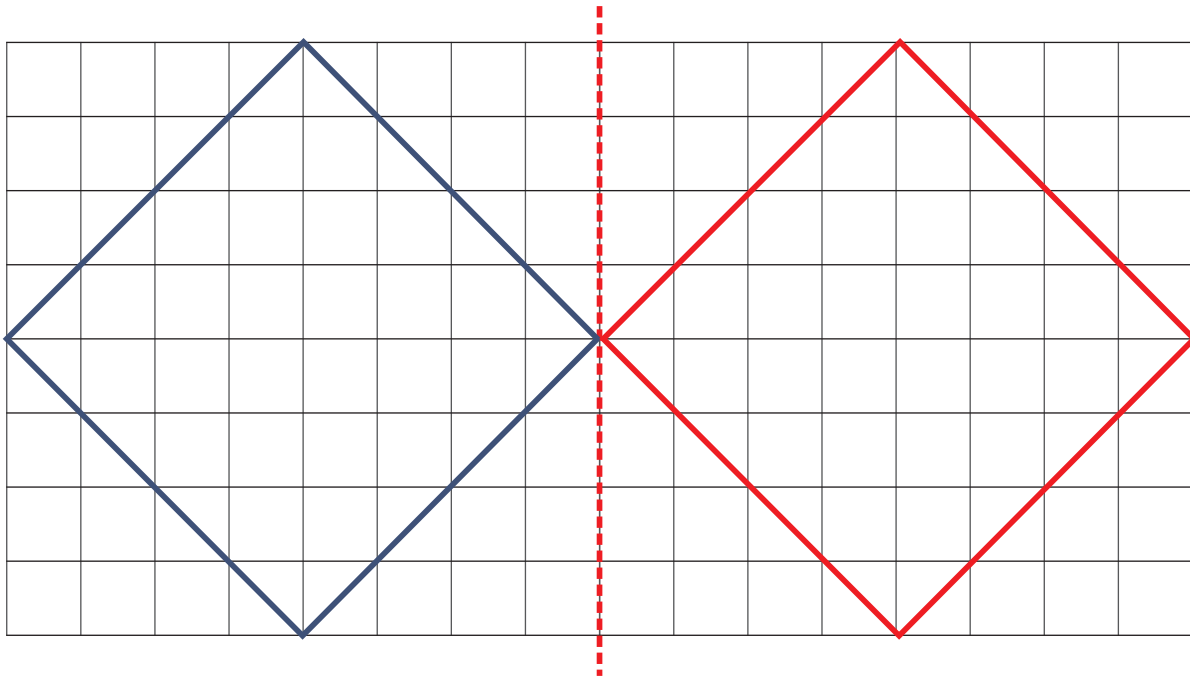



Achsensymmetrie



Spiegle die Figuren an der Spiegelachse.

