

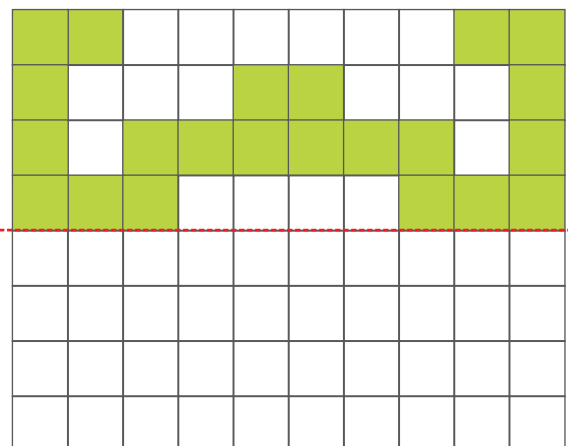

## Symmetrie

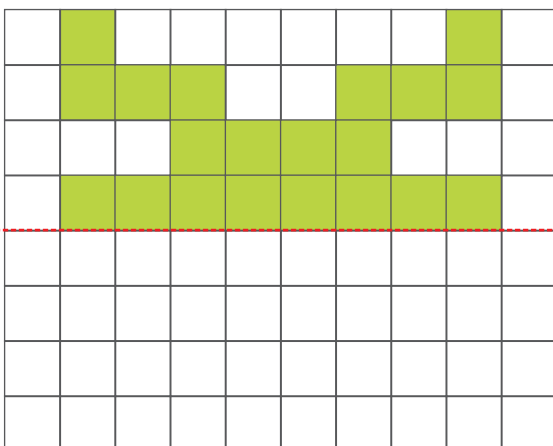

Ergänze die Figuren gespiegelt (achsensymmetrisch).

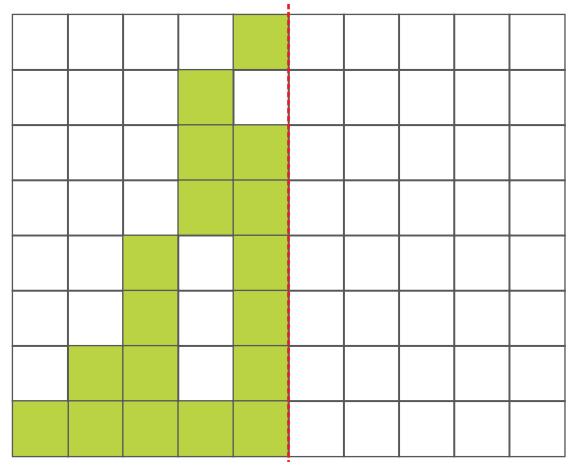
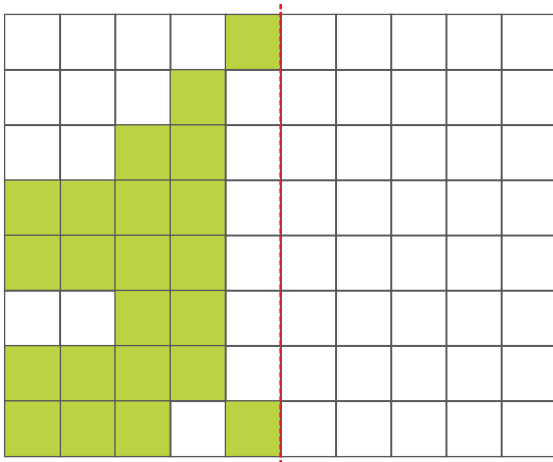
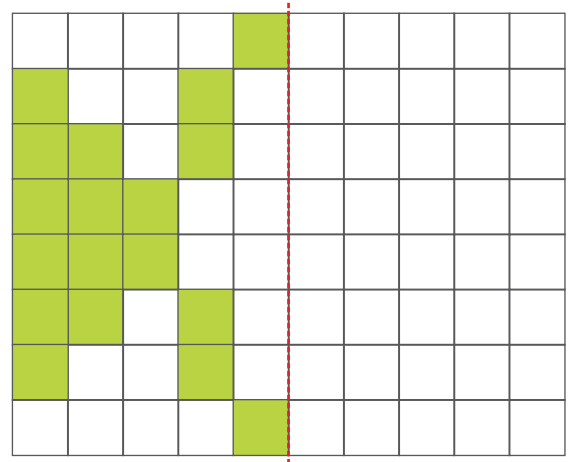
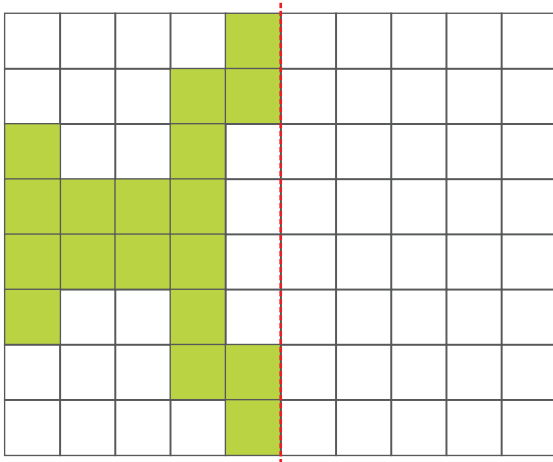

## Symmetrie



Ergänze die Figuren gespiegelt (achsensymmetrisch).

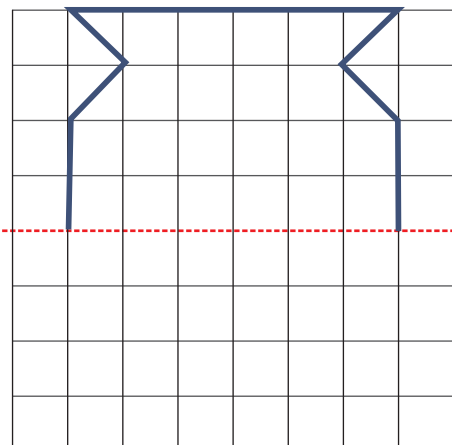
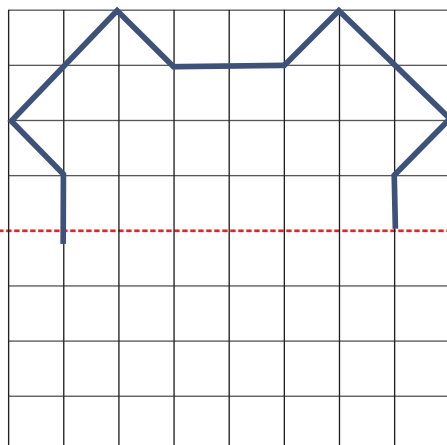
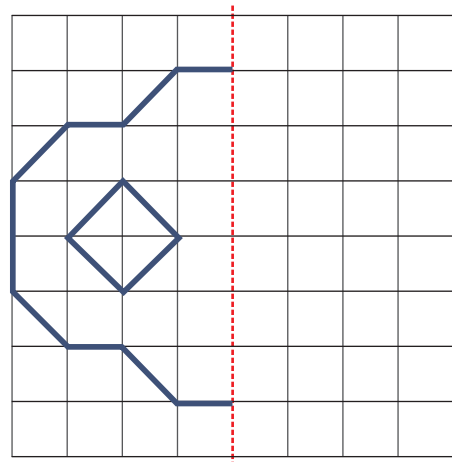
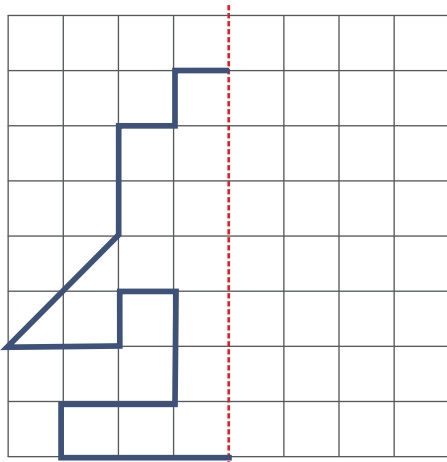
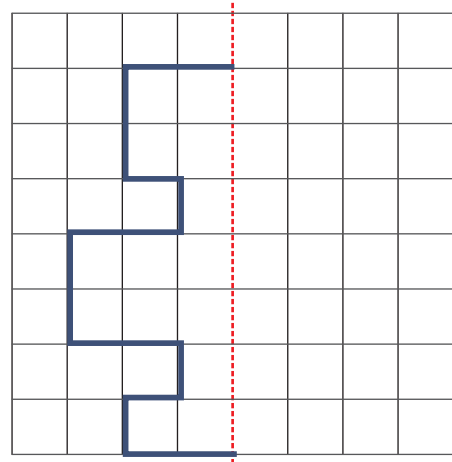
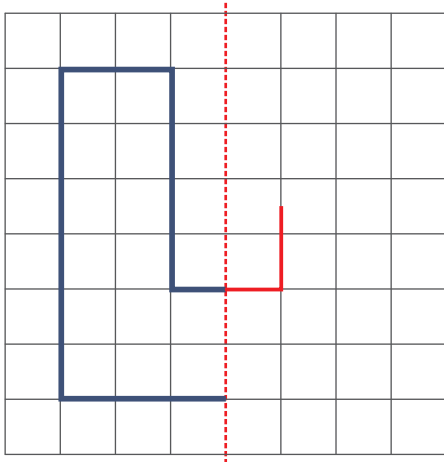



## Achsensymmetrie



Trage alle möglichen Spiegelachsen in den Figuren ein.

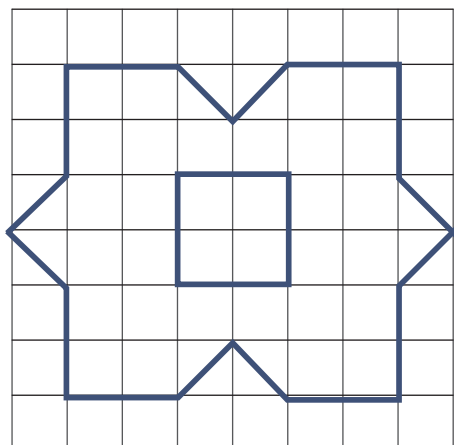
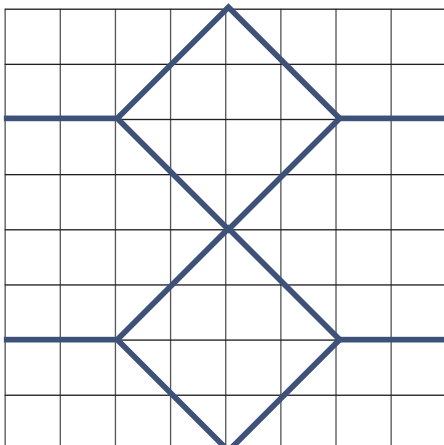
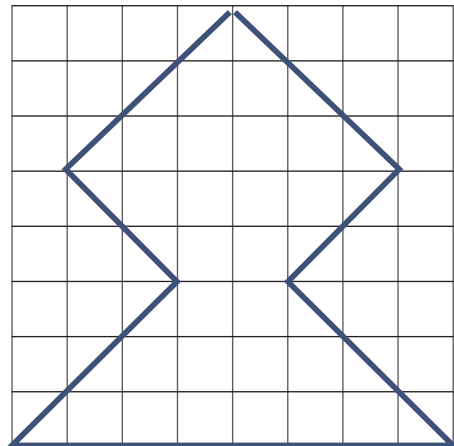
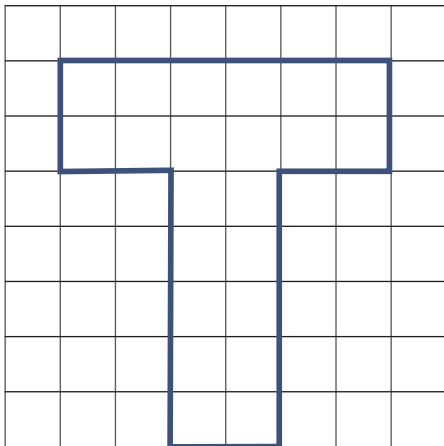
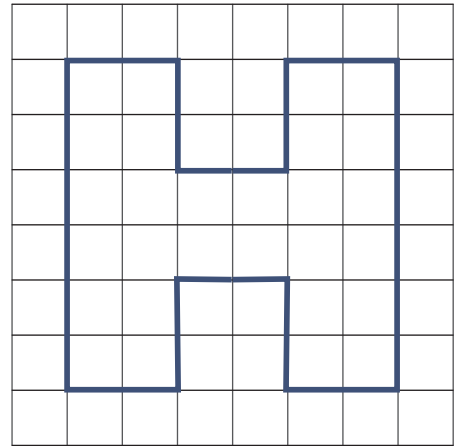
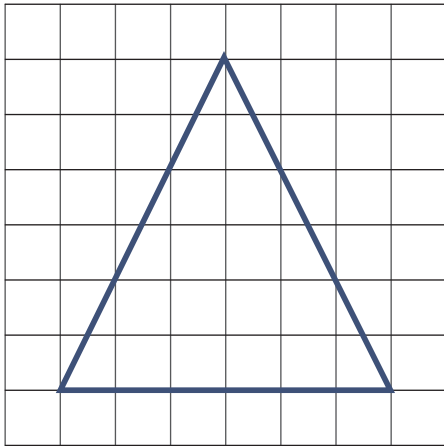



## Achsensymmetrie



Spiegle die Figuren an der Spiegelachse.

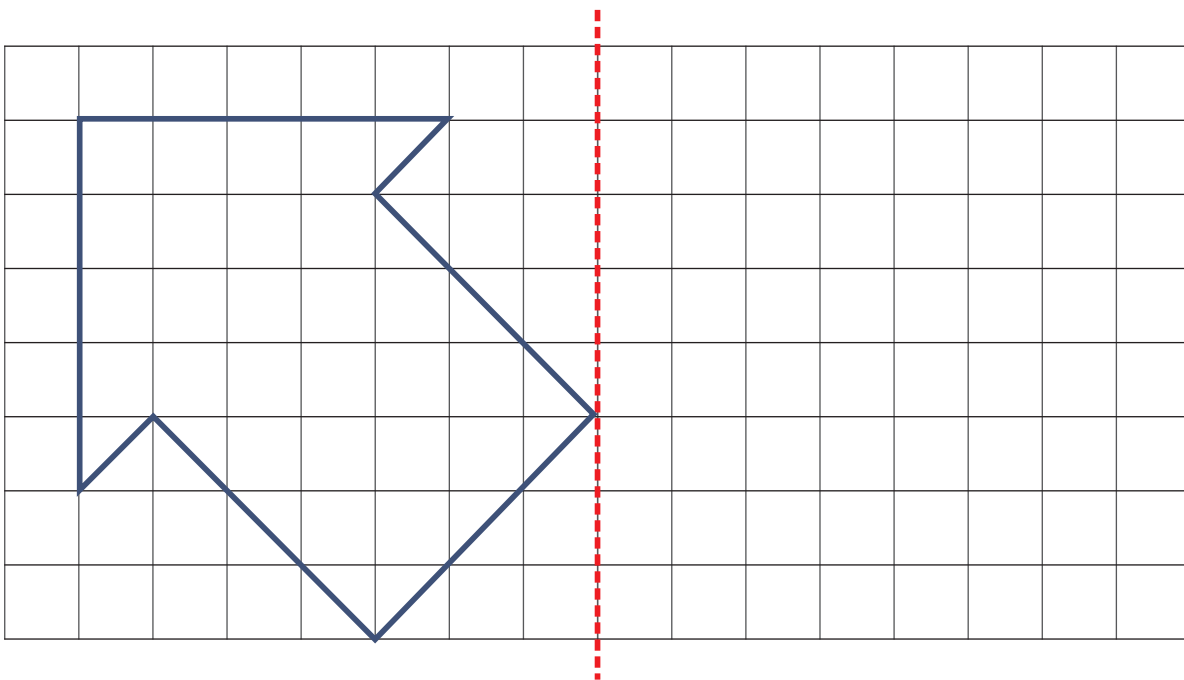
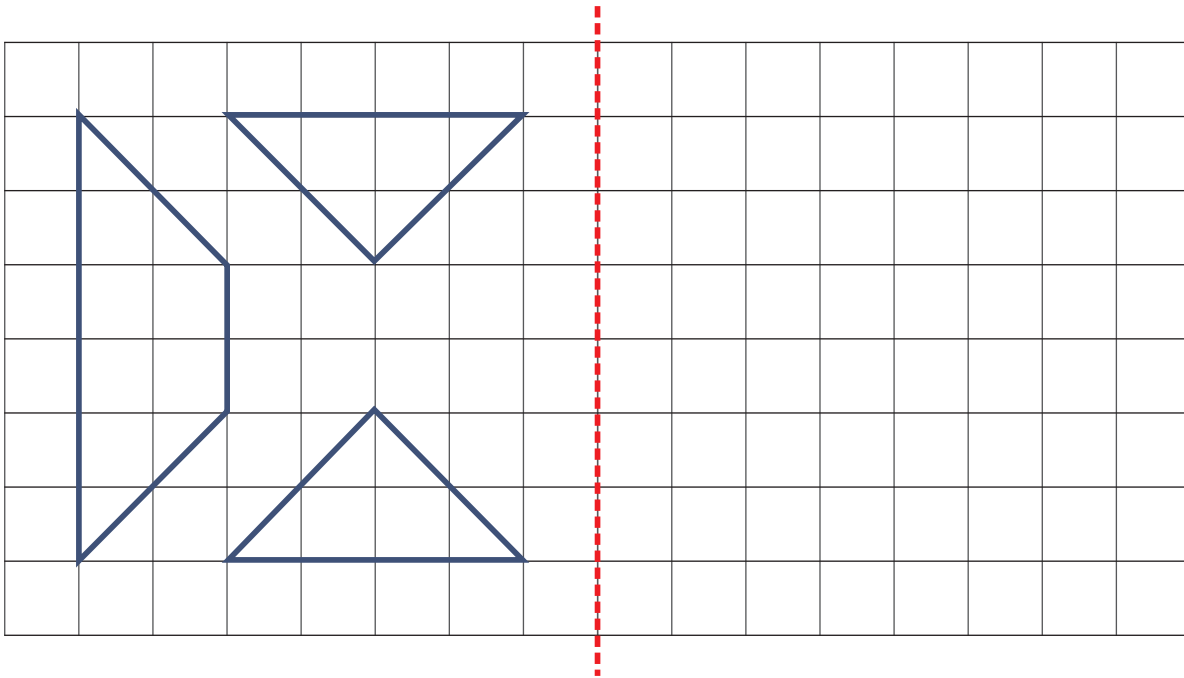



## Achsensymmetrie



Spiegle die Figuren an der Spiegelachse.

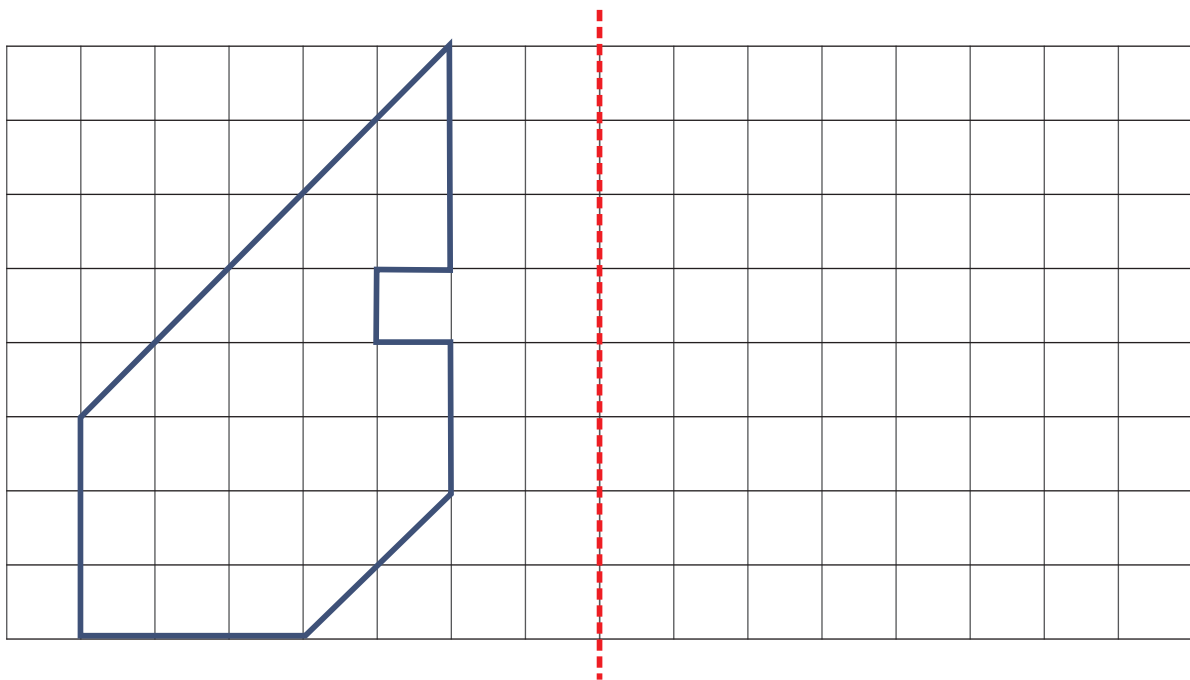
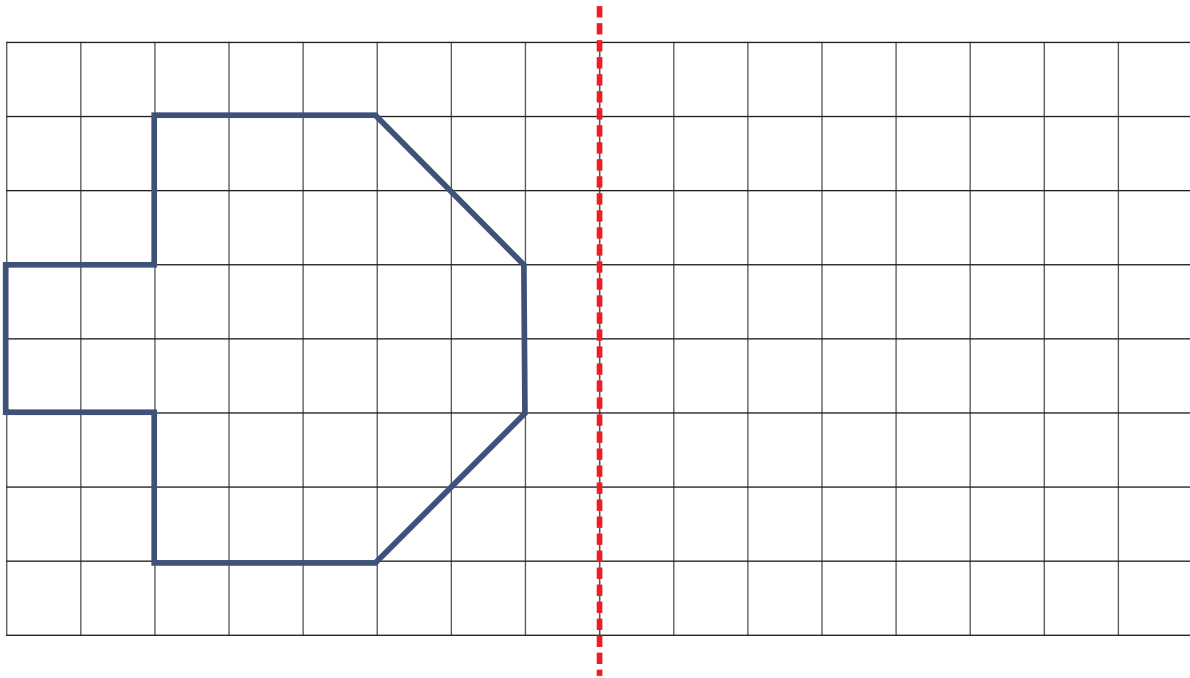



### Symmetrie



Ergänze die Figuren gespiegelt (achsensymmetrisch).

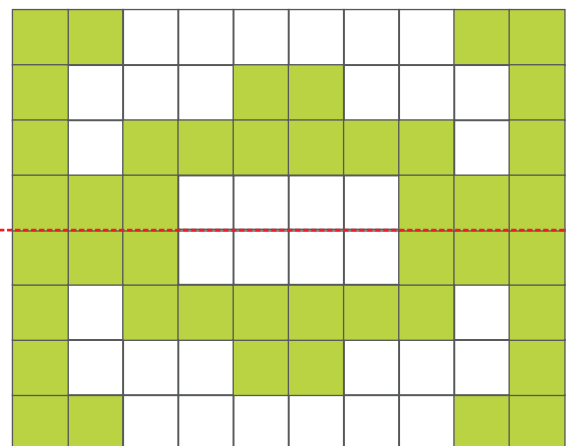
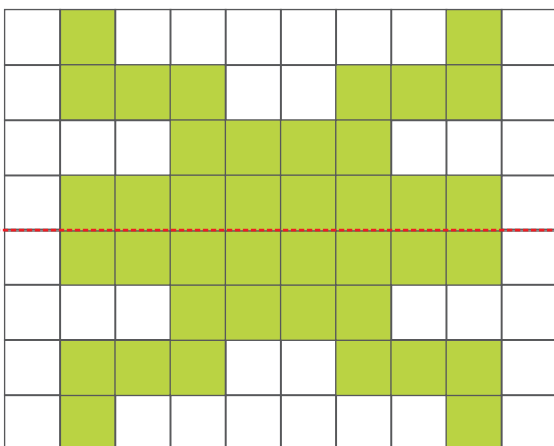
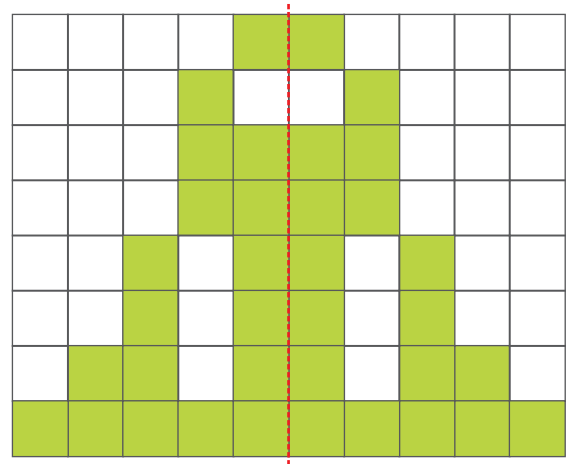
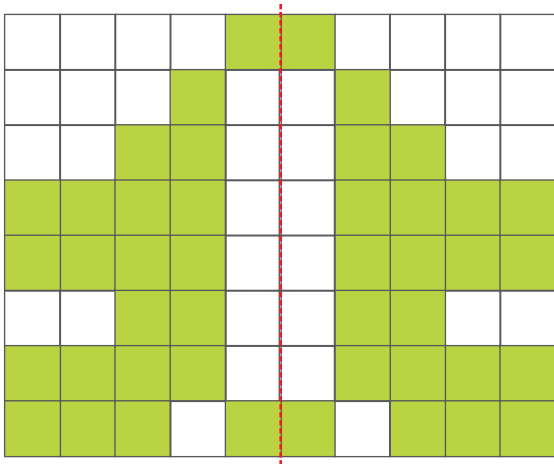
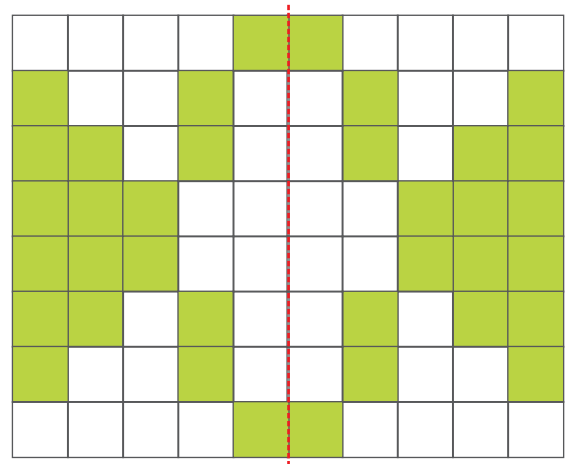
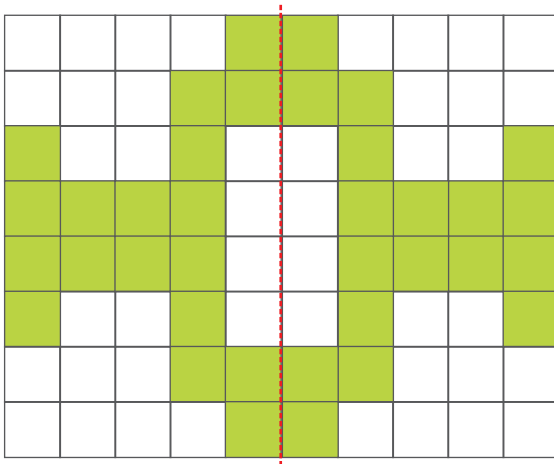

### Symmetrie



Ergänze die Figuren gespiegelt (achsensymmetrisch).

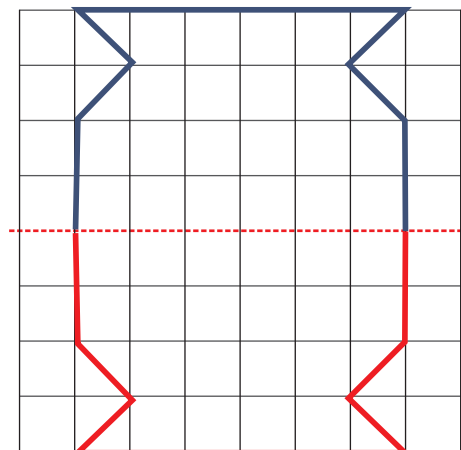
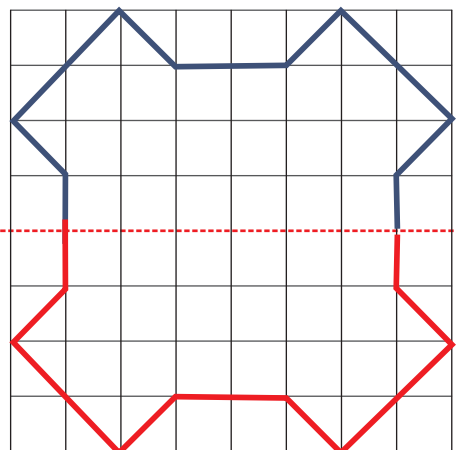
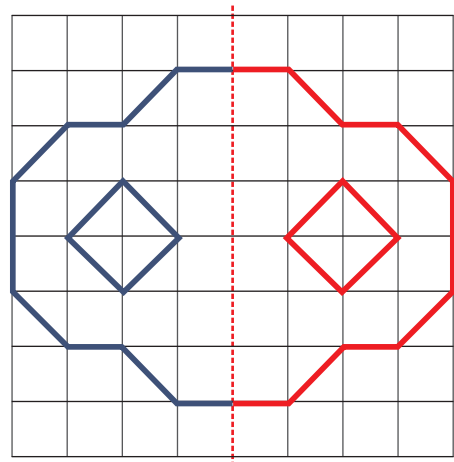
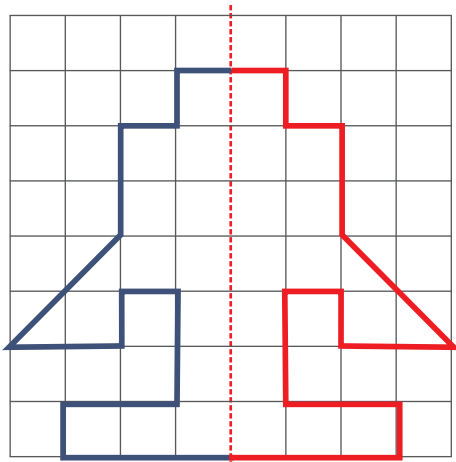
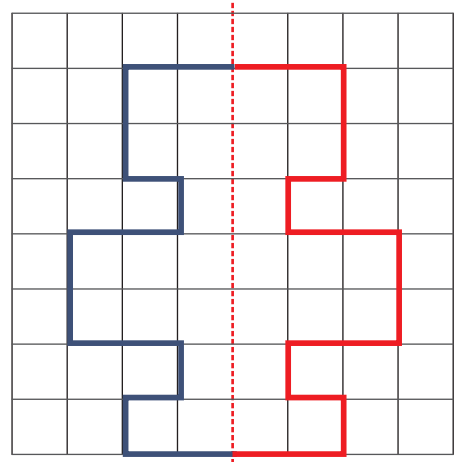
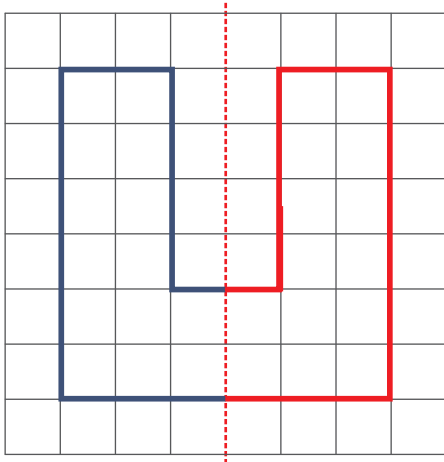

### Symmetrie



Ergänze die Figuren gespiegelt (achsensymmetrisch).

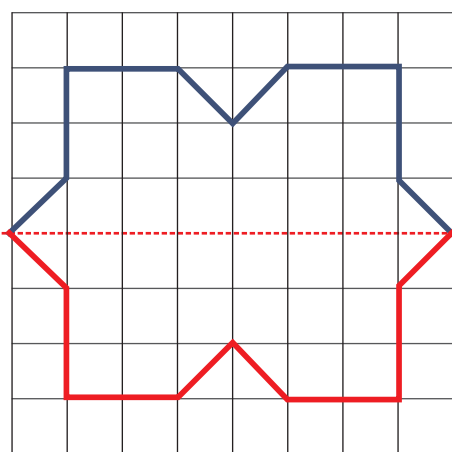
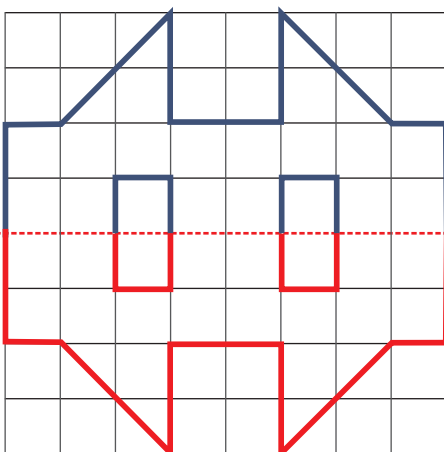
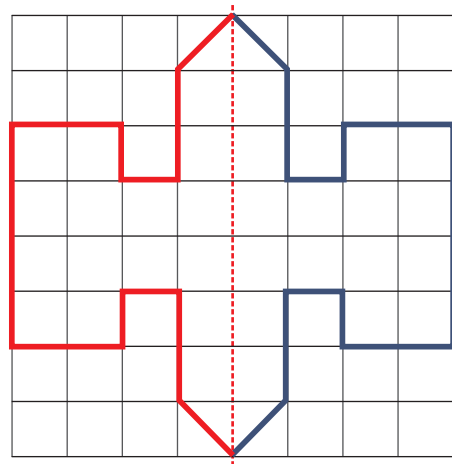
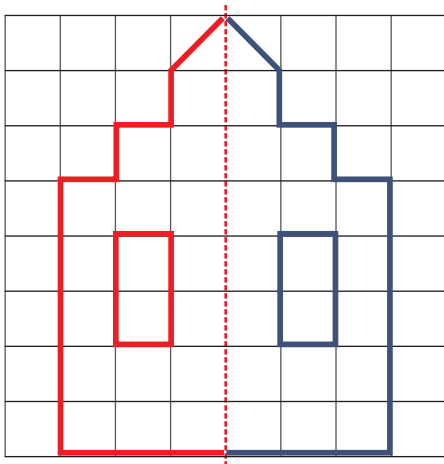
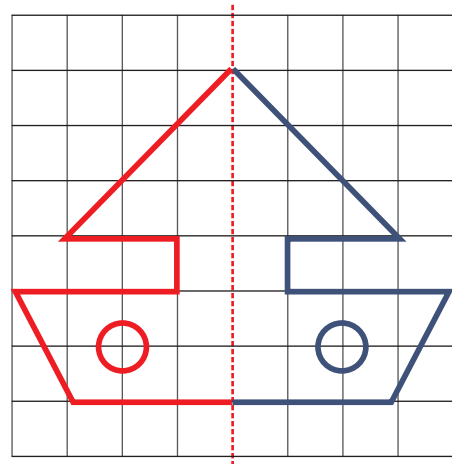
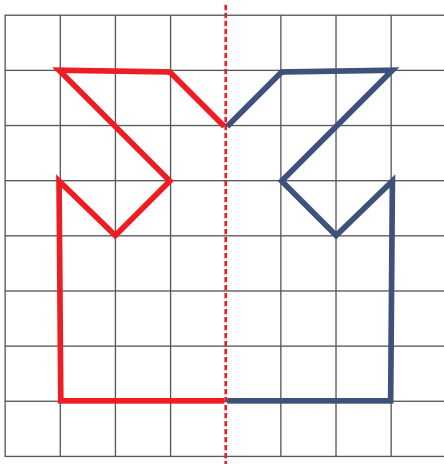

### Achsensymmetrie



Trage alle möglichen Spiegelachsen in den Figuren ein.

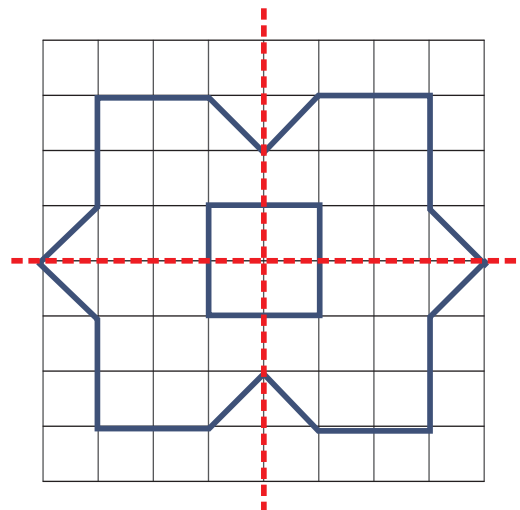
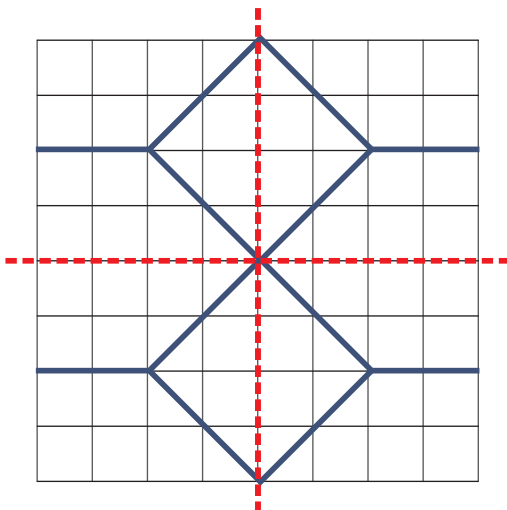
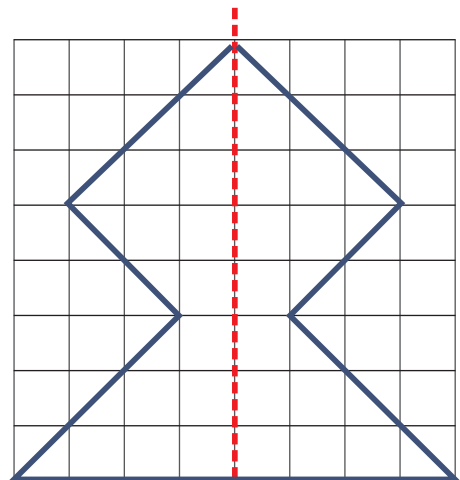
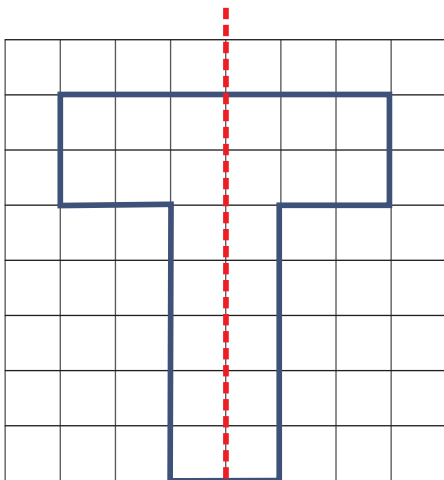
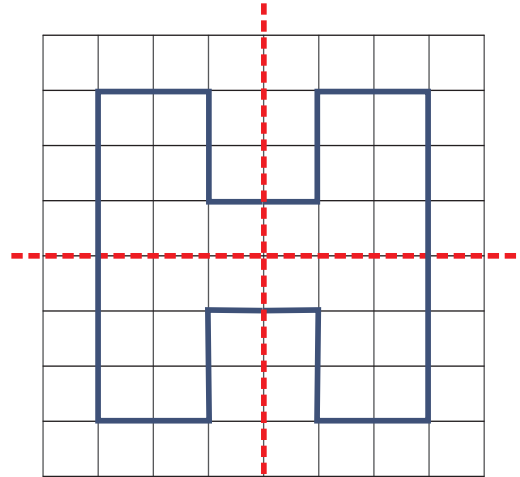
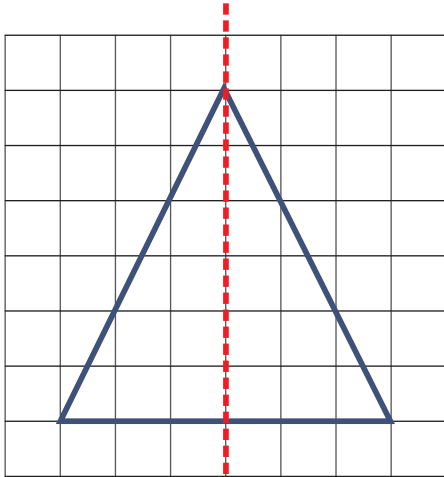

### Achsensymmetrie



Spiegle die Figuren an der Spiegelachse.

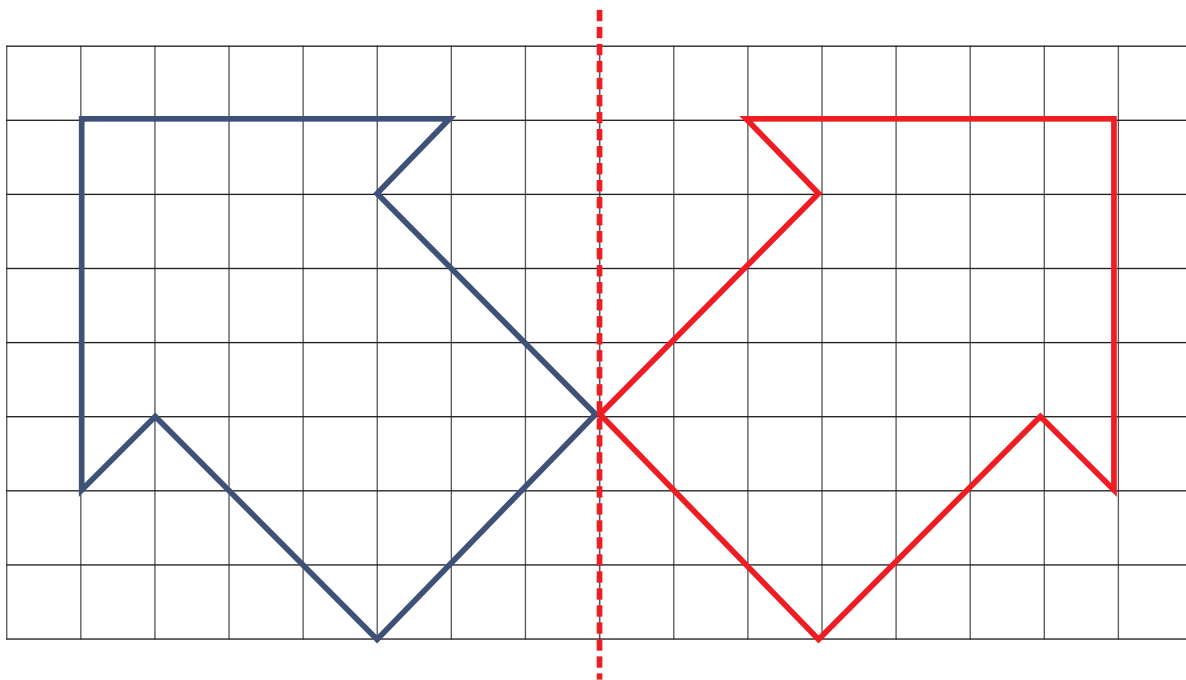
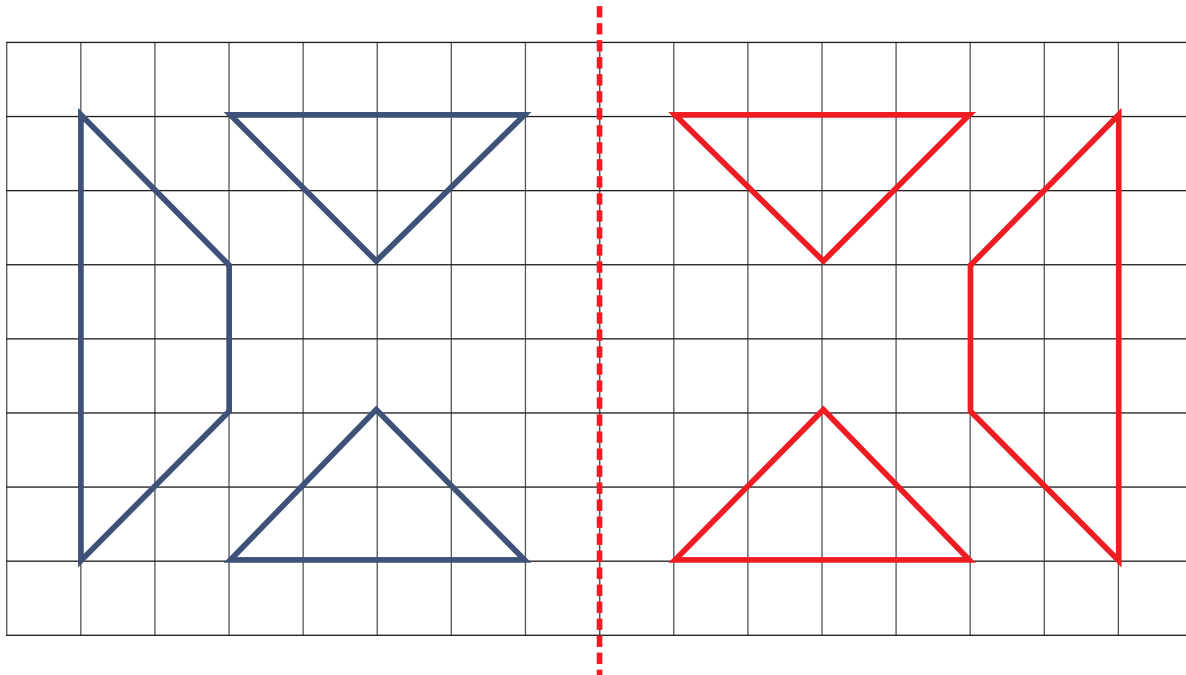

### Achsensymmetrie



Spiegle die Figuren an der Spiegelachse.

